

1.A legjobb- munkákból összeállított tanmentek képei

A következőkben megpróbálom bemutatni, hogyan nézne ki képes tanmenetünk, ha a legjobb, illetve ha a leggyengébb tanulói munkákkal illusztrálnánk. Persze a válogatás esetleges, a szabad témafeldolgozások órát pedig egyelőre csak egyetlen munka képviseli, és az órák választható feladatai is ritkásan szerepelnek.

Legjobb munkák EGYEB\SORSOK\jokepek98.doc

Mit várhatunk a legjobb (nem szakkörös) tanulóktól?

5. o.

-



Godó Gabriella, 5. o.

-

-



2.

-

-

-

-

-

-

-

-

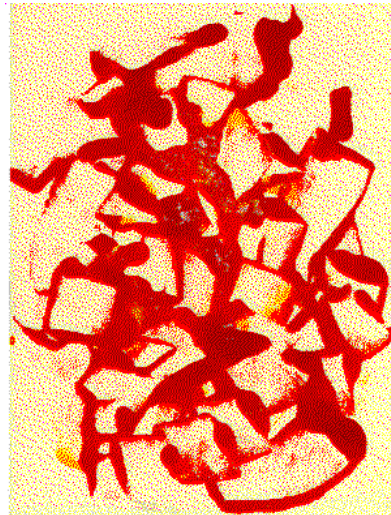

Debreceni Csaba? 5.o





4 . Mesebeli erdő



3. Mesebeli növény. Csabai Ágnes

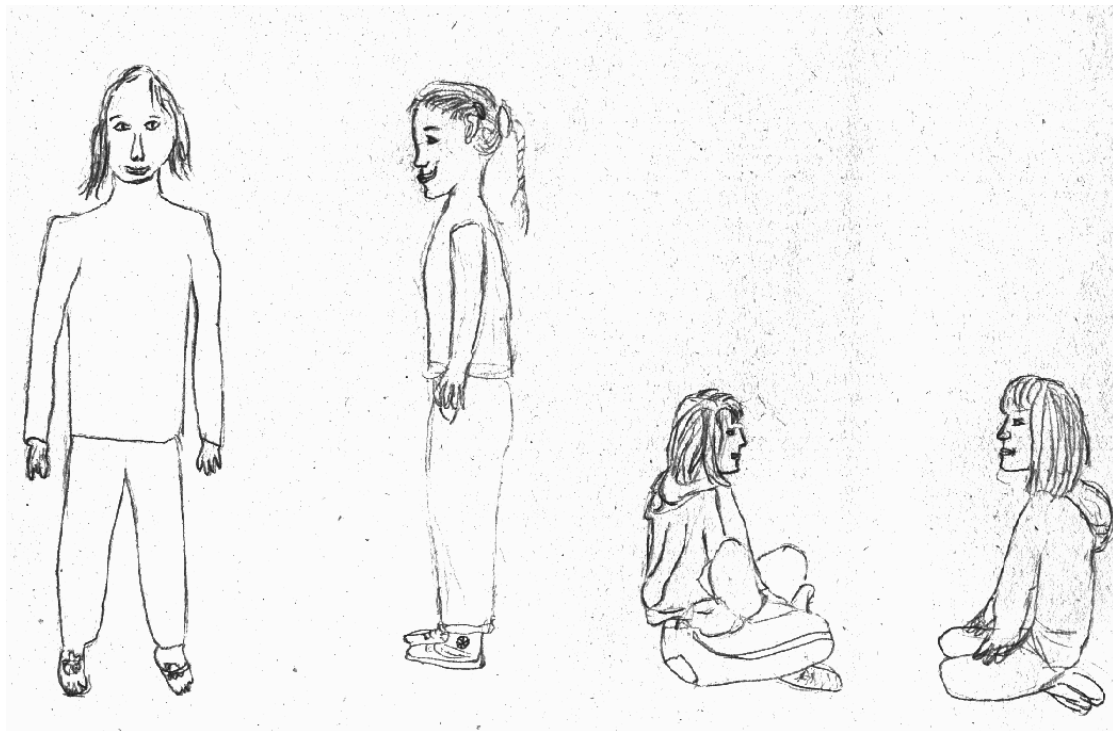

5. Alakrajz

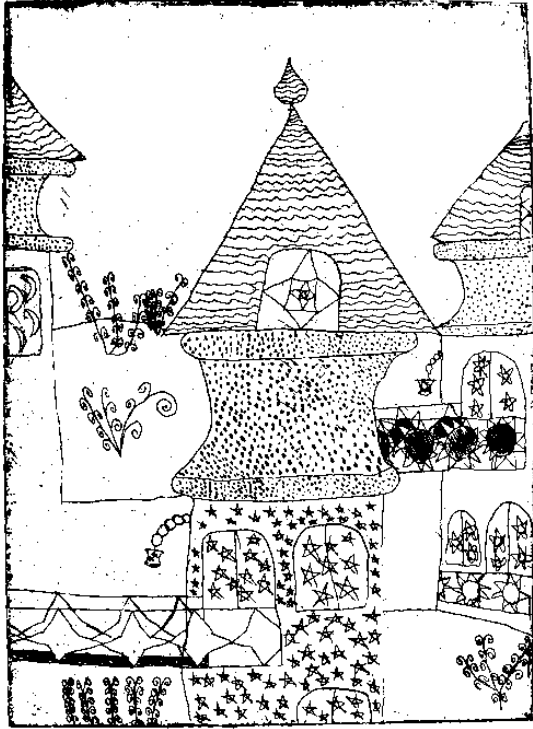

6. Mesebeli épület



Farkas Dorca 5. O.



7. Mesebeli madár



Tenkei Olga 6. O. Mesebeli emberek



8. Mesebeli állatok



Fecsó Andrea 5. O. Portré

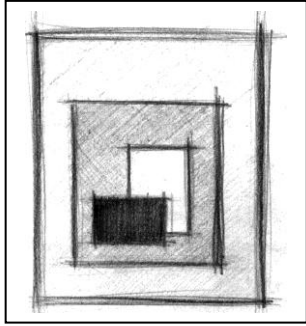

6. o.

Tónusos rajz

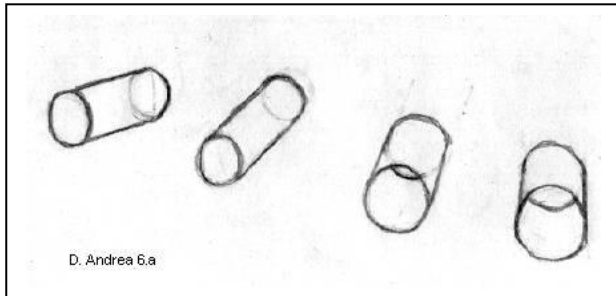
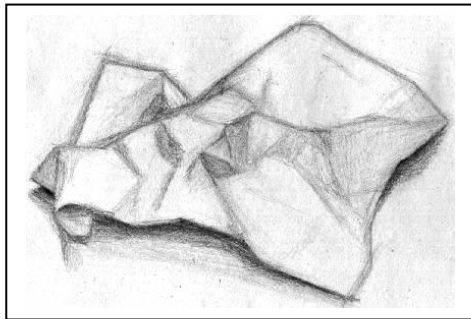
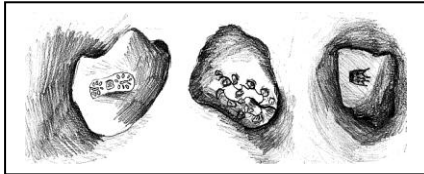

D. Andrea 6.a

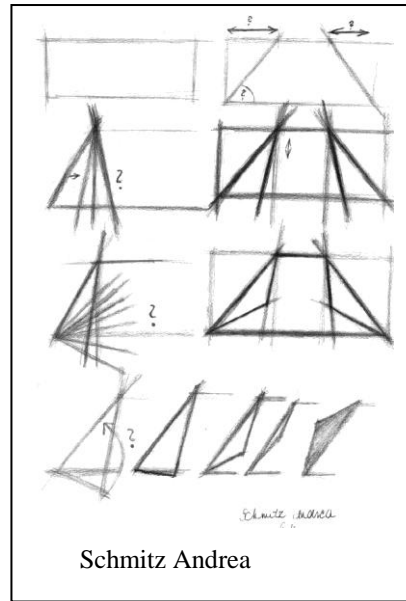

Schmitz Andrea

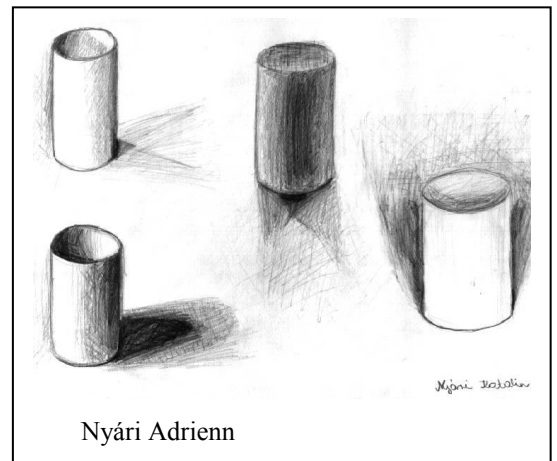
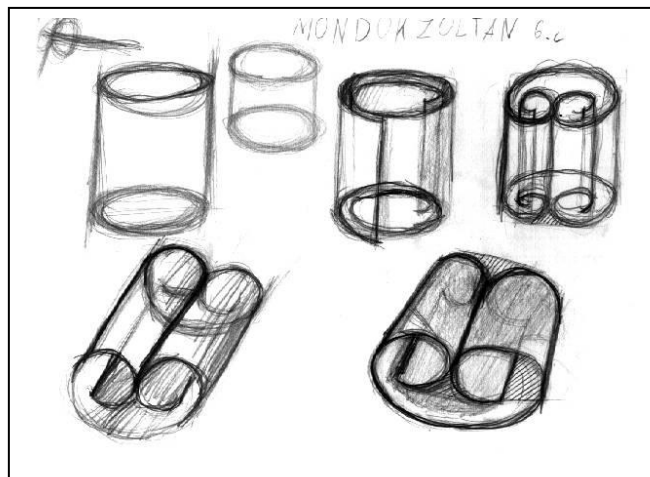
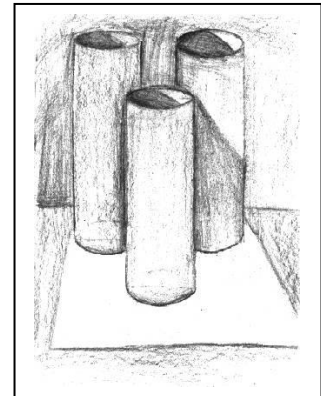

Nyári Adrienn

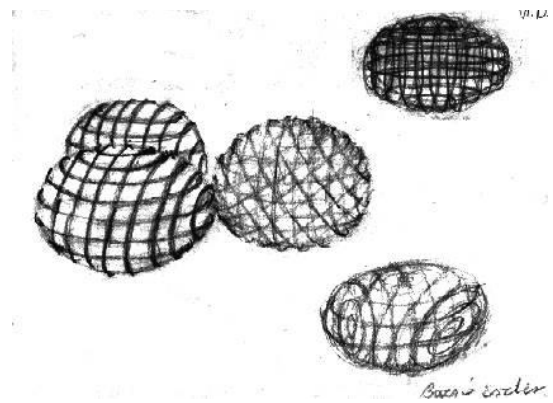
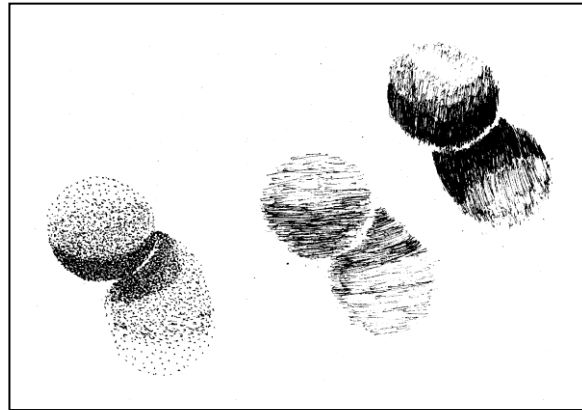
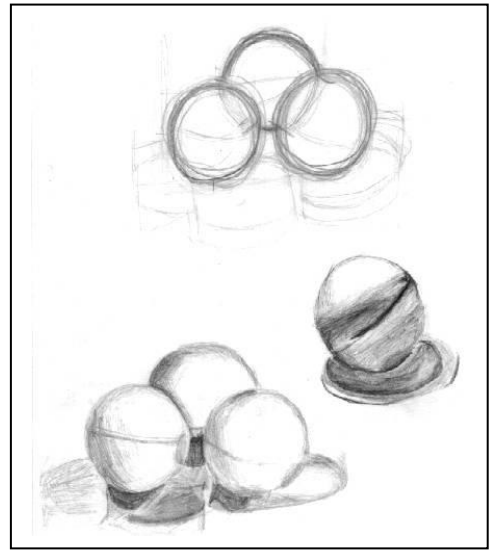
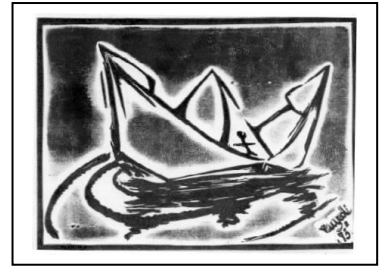
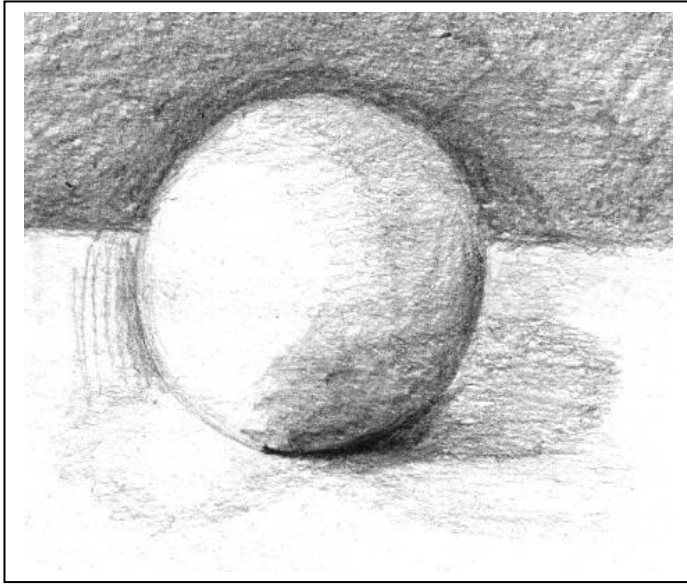

Buenos Aires

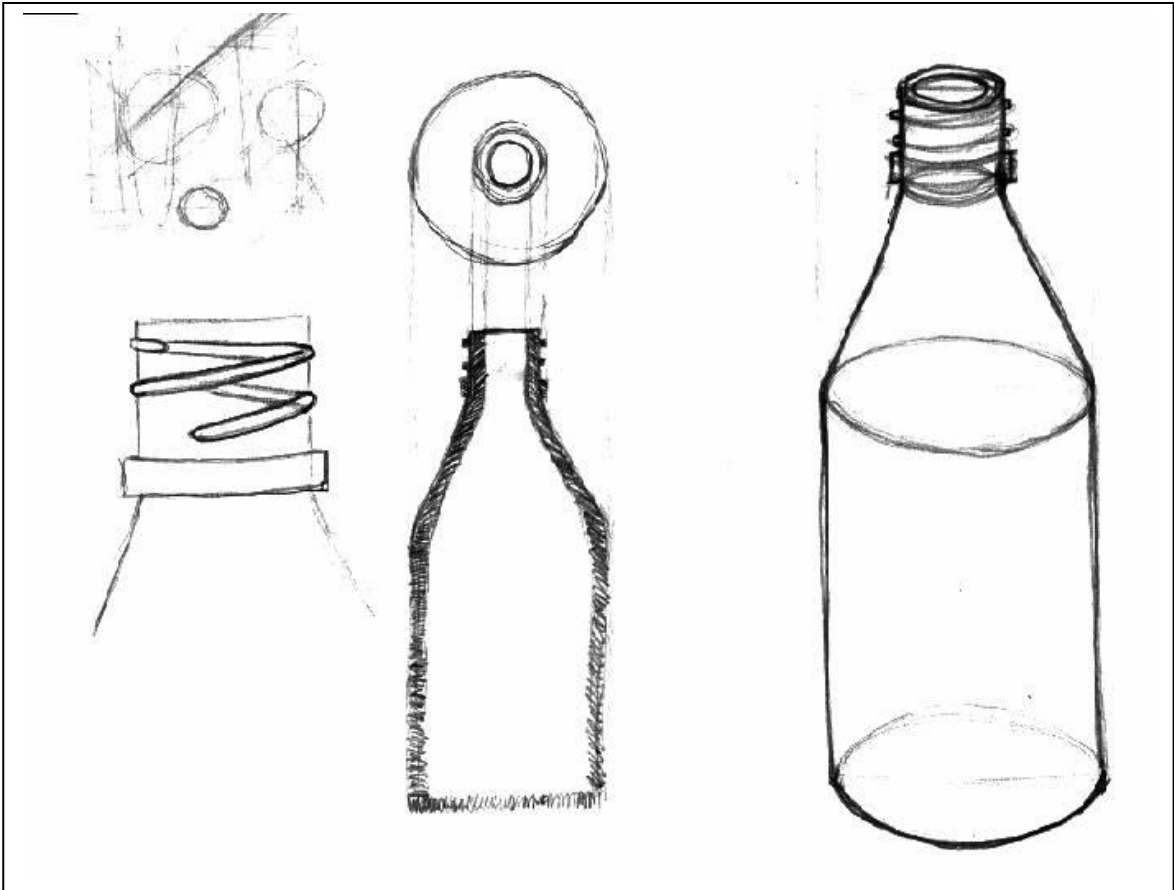
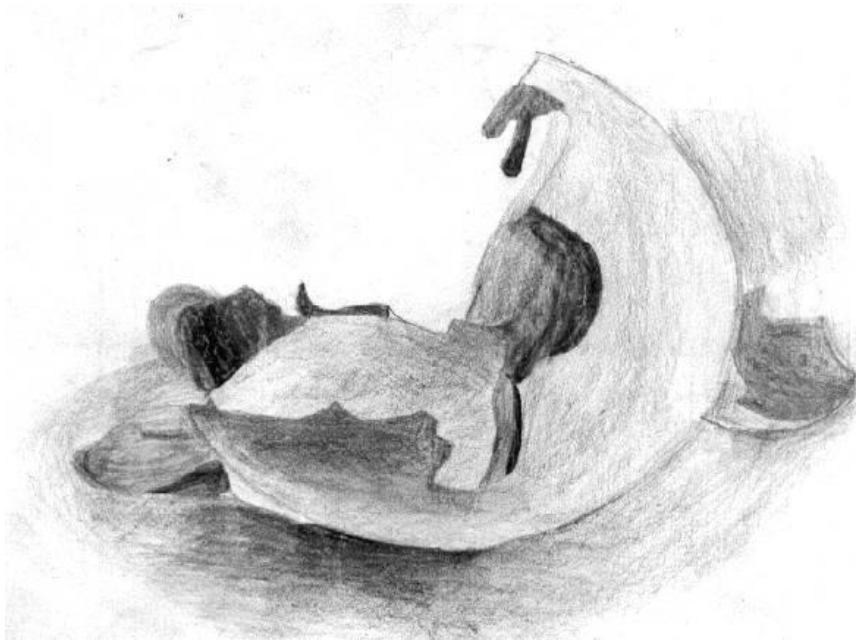

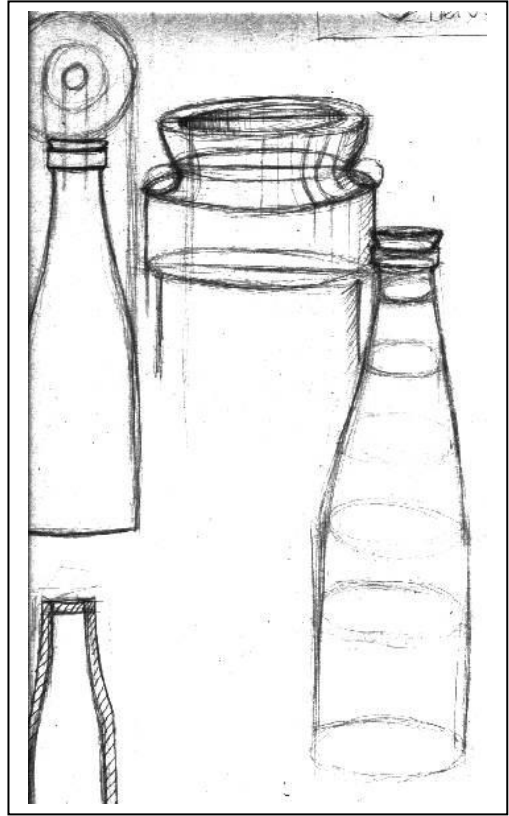
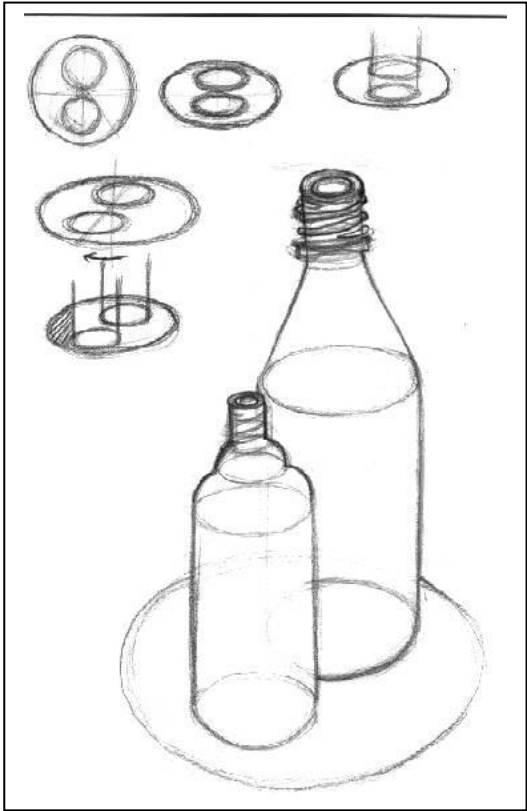

14



15

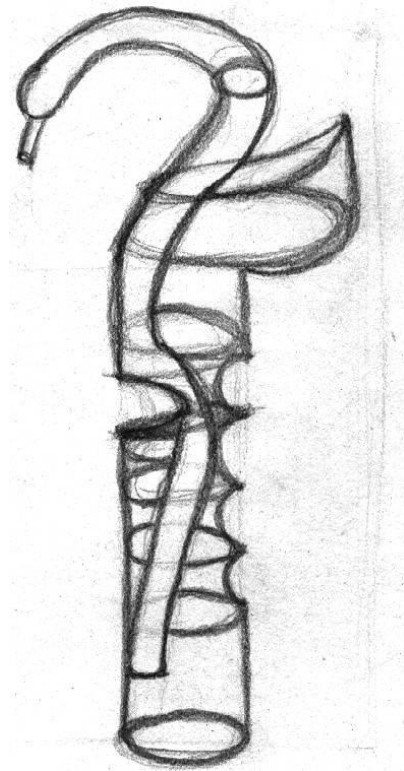
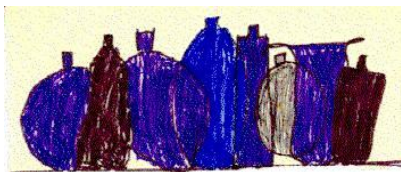
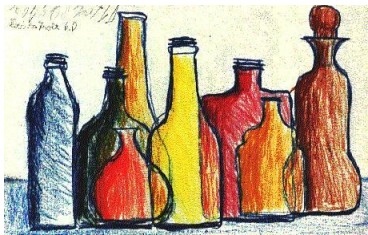

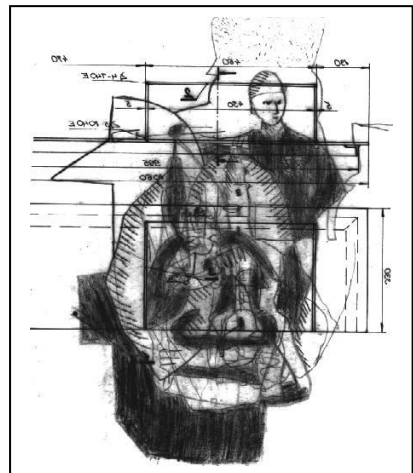
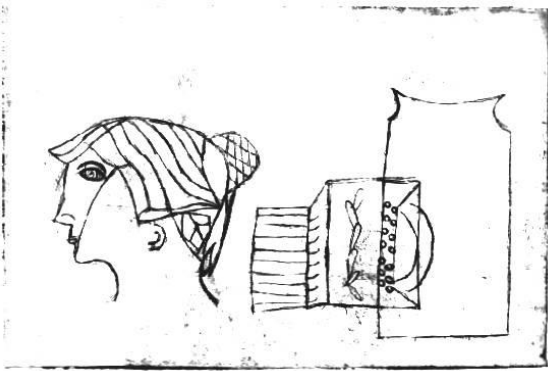

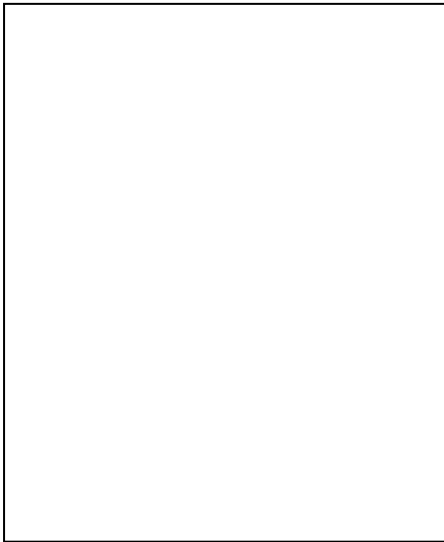

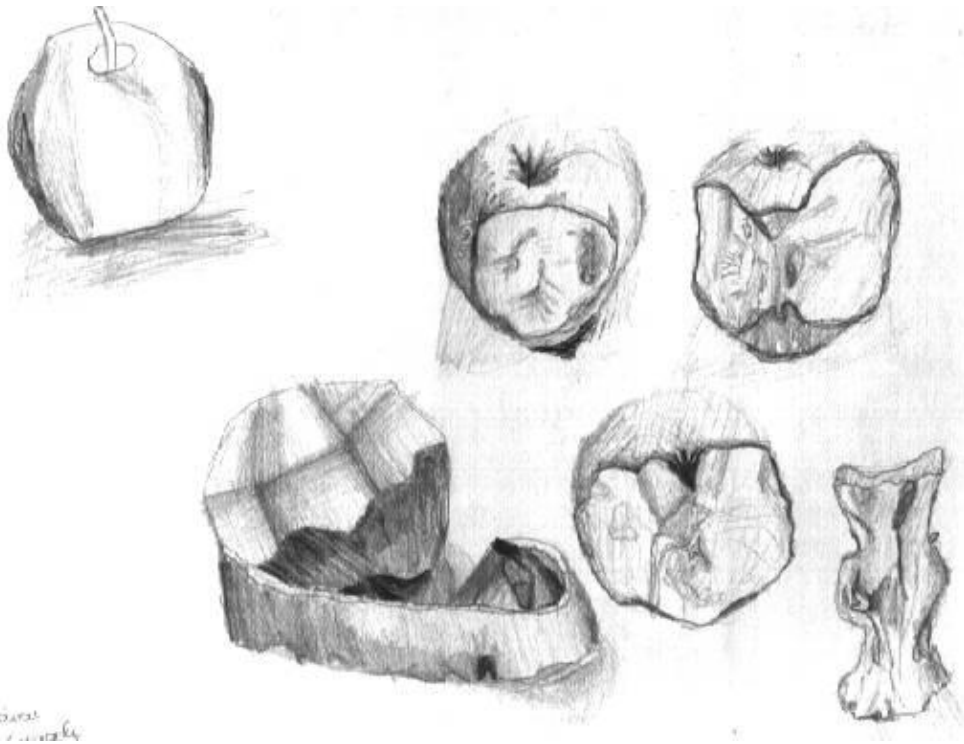
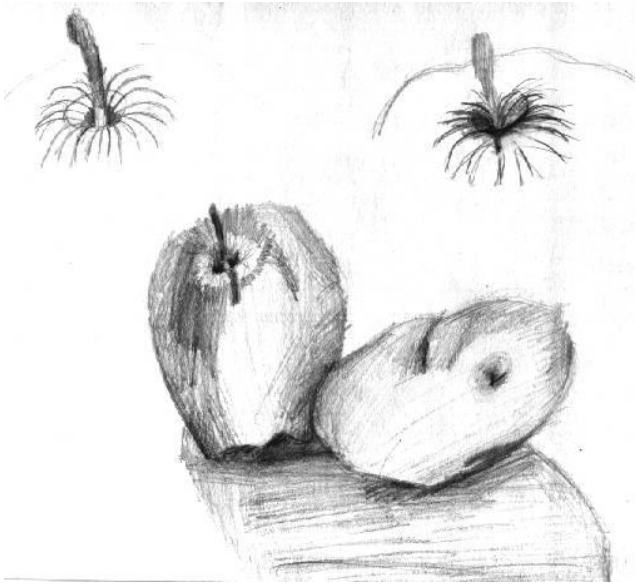

0001
2004

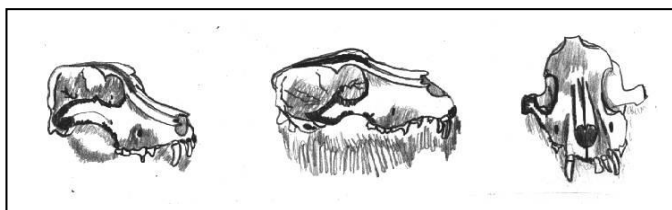
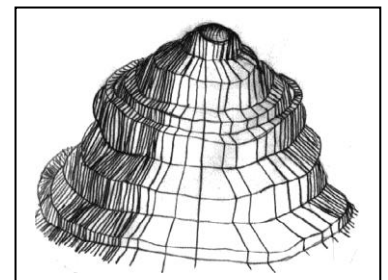
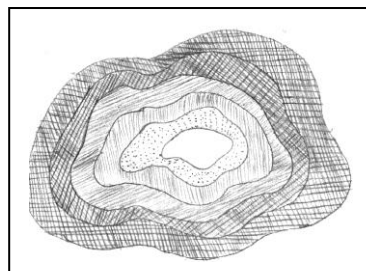
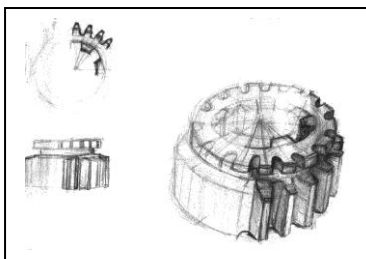
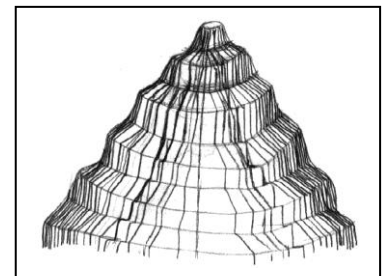
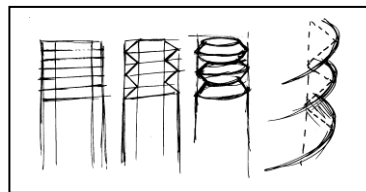
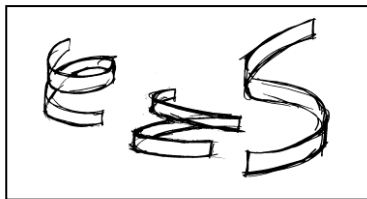
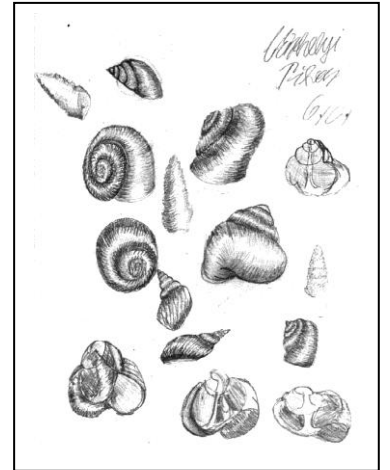
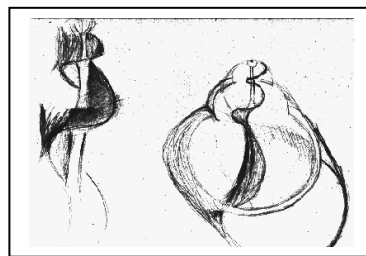
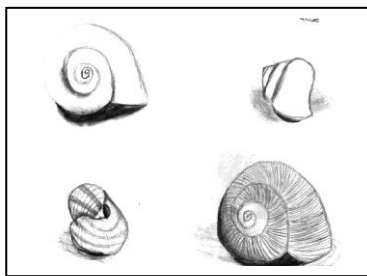
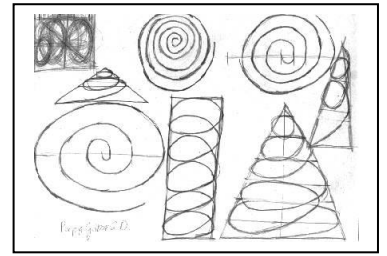
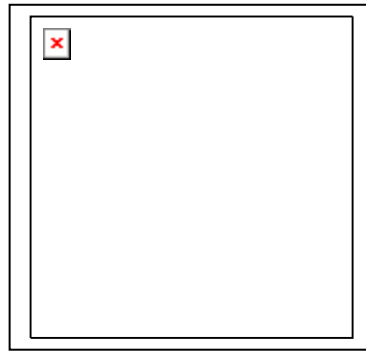
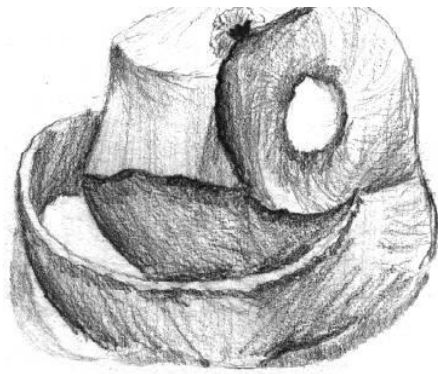

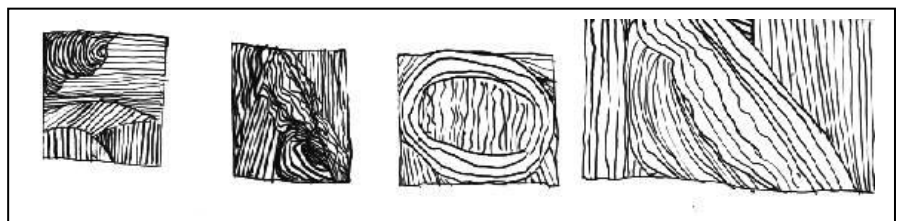
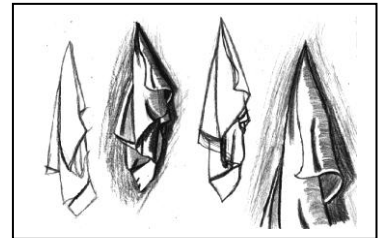
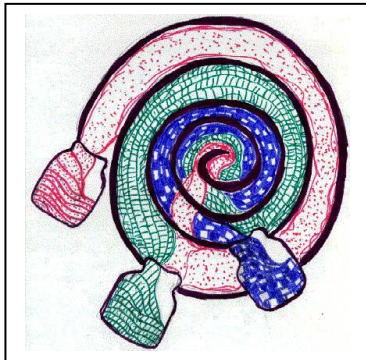
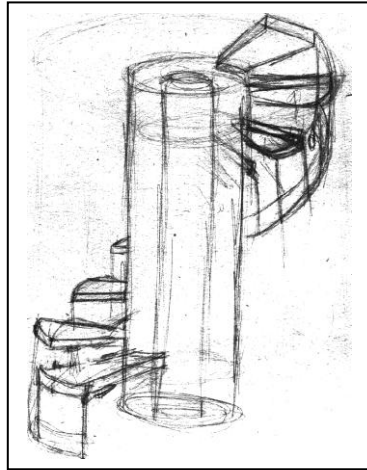
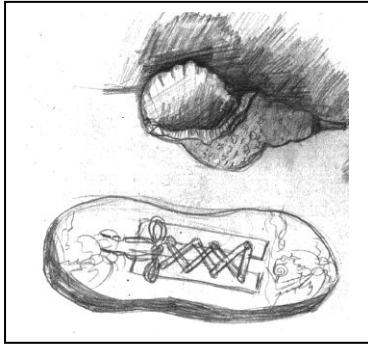

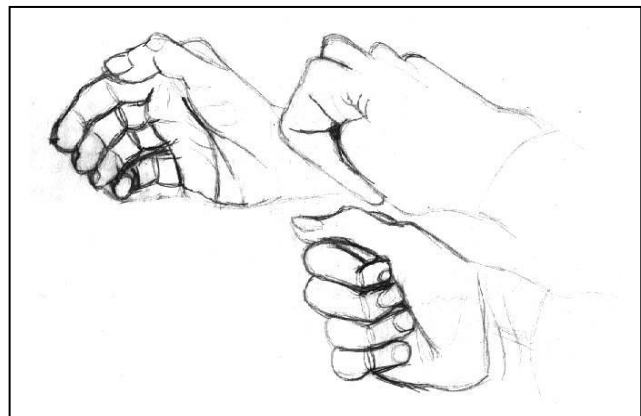
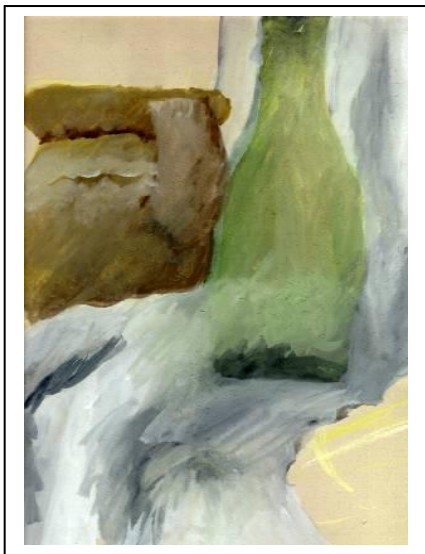
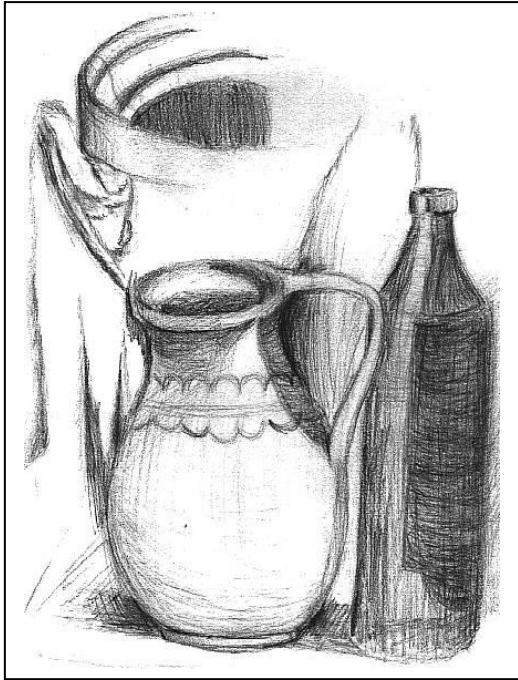

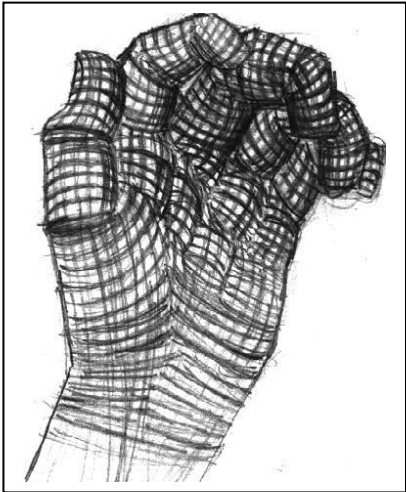

Hetedik osztály

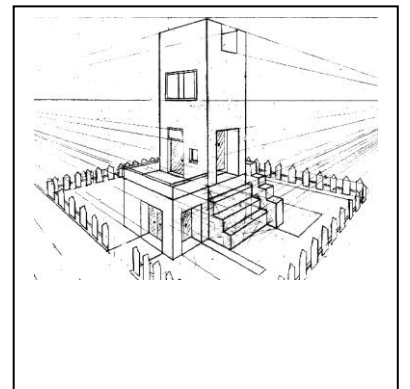
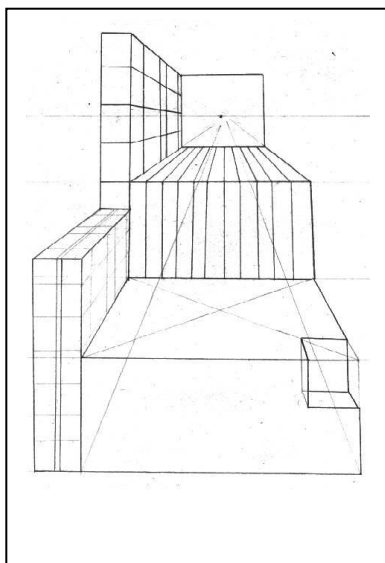
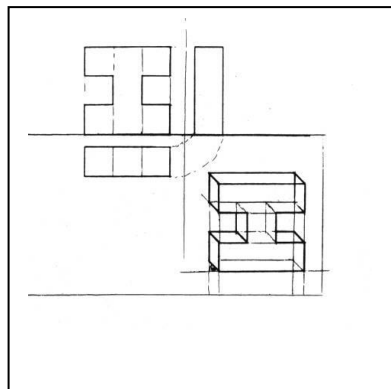
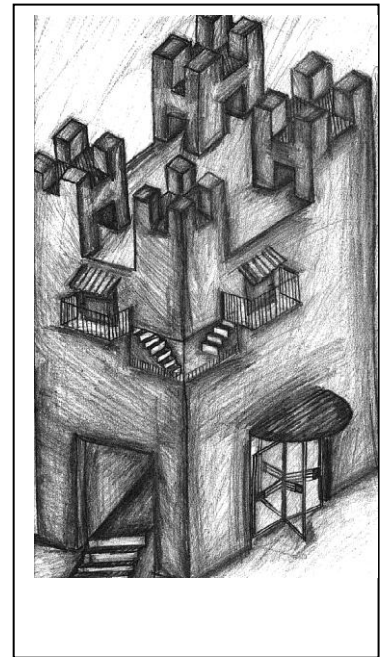
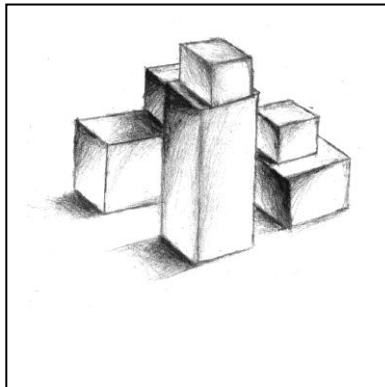
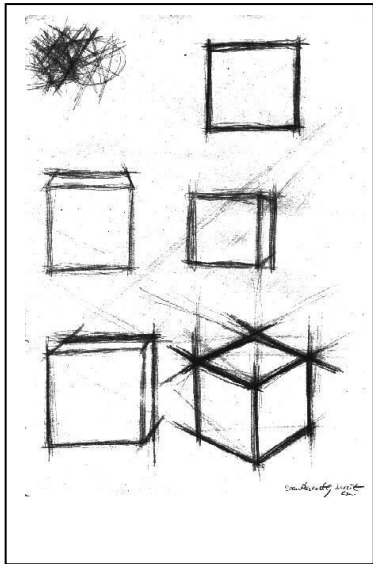

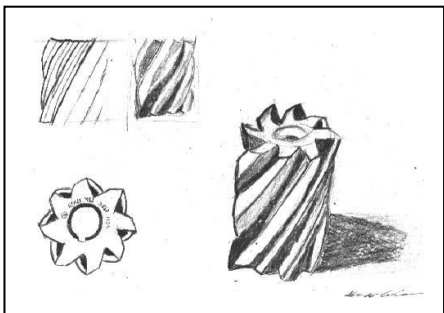
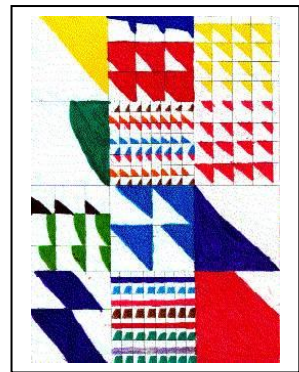
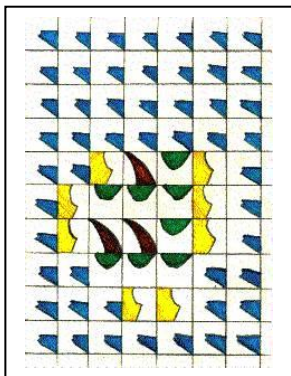
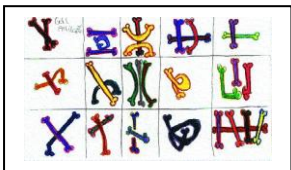
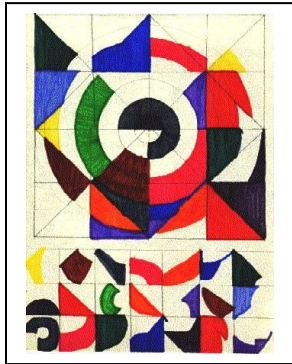
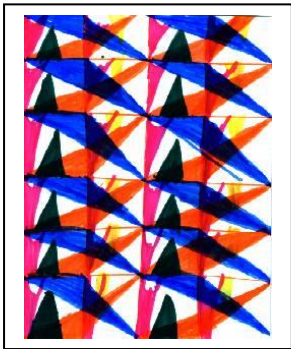
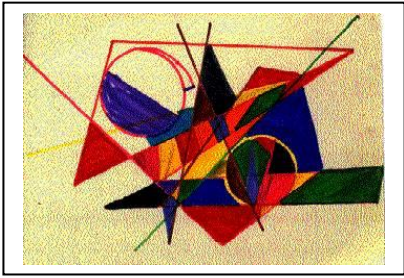
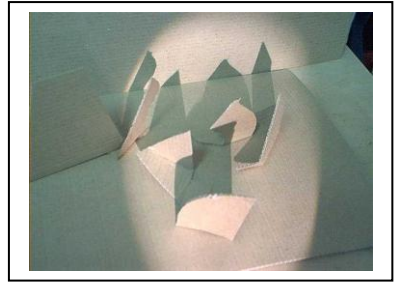
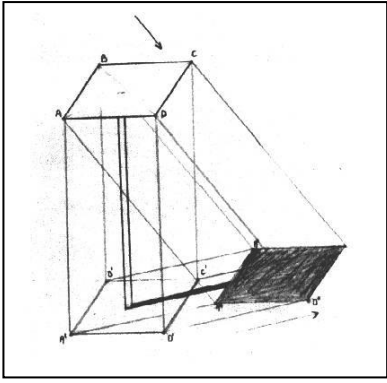

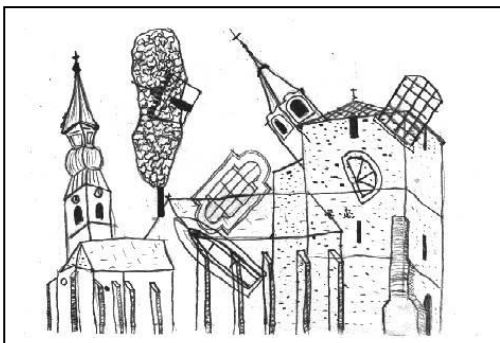
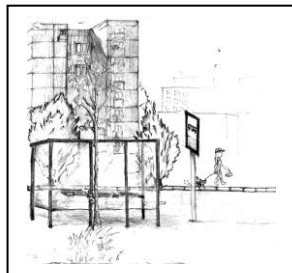
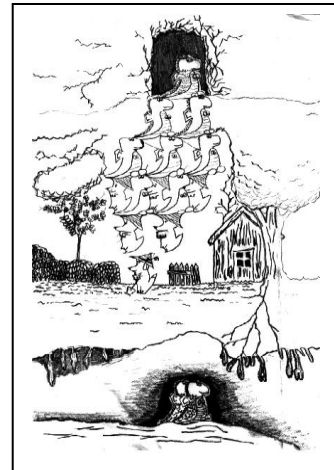
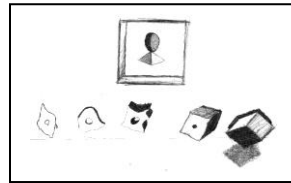
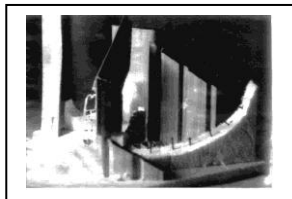
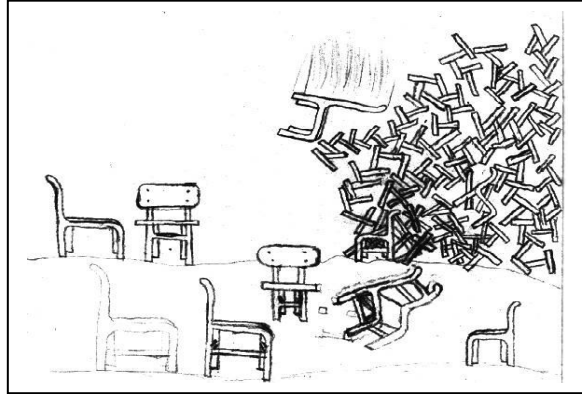
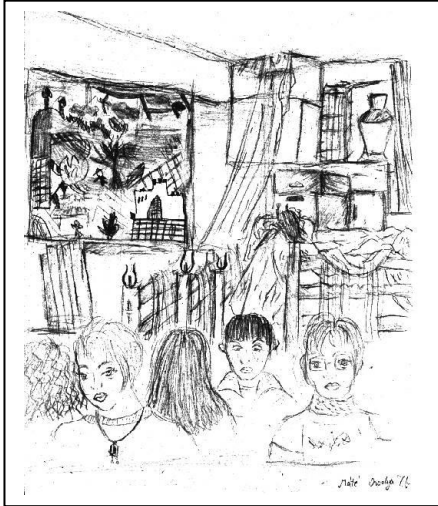
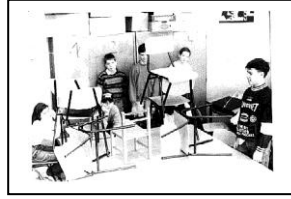
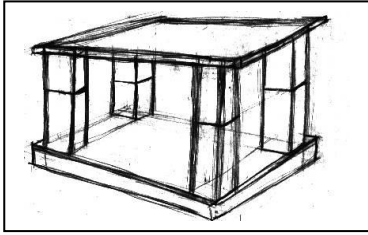

8. osztály

